

AGM TECHNOLOGY
ABT PowerLine SGP Series

SGP6-225

6V 225Ah(20hr)

ABT PowerLine SGP Series is a general purpose battery according to Eurobat Classification with 10 years design life for standby application. As with all ABT batteries, all are rechargeable, highly efficient, leakage proof and maintenance free.

Complying standards:

IEC 61056-1/2-2002
JIS C8702-1/2-2009



Specification

Cells Per Unit	3
Voltage Per Unit	6V
Nominal Capacity 20°C (68°F)	225Ah @20hr-rate to 1.75V Per cell 208.9Ah @10hr-rate to 1.75V Per cell 140.9Ah @1hr-rate to 1.60V Per cell
Weight	Approx. 34.90kg(76.95lbs)
Maximum Discharge Current	1800A (5 sec)
Short circuit current	2643A
Maximum charge current	67.5A(30% of rated capacity)
Internal Resistance	Approx. 2.27 mOhms
Mass Energy(Wh/kg)	38.68
Volumic energy(Wh/L)	106.5
Operating Temperature Range	Discharge -20~60°C; Charge -10~60°C; Storage -20~60°C
Nominal Operating Temperature Range	20°C±3°C (68°F±5°F)
Float Charging Voltage	6.75 to 6.90 VDC/unit Average at 20°C(68°F)
Equalization and Cycle Service	7.20 to 7.50VDC/unit Average at 20°C(68°F)
Self Discharge	ABT batteries can be stored for more than 6 months at 20°C(68°F). Please charge batteries before using. For higher temperatures the time interval will be shorter.
Terminal	Insert thread and bolt M8×18
Torque strength in Nm	12~16
Container Material	ABS(UL94-HB) Flammability resistance of UL94-V0 can be available upon request.
Handle Type	Rope
Flame arrester	Yes

Dimensions / Terminal

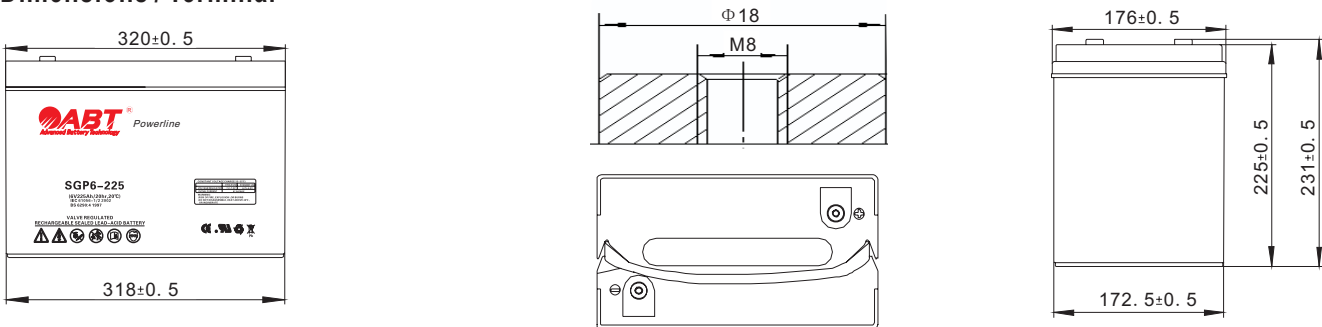

Constant Current Discharge Data (Amperes at 20°C)

End Volt. Per Cell	5min	10min	15min	30min	1h	2h	3h	4h	5h	8h	10h	20h	24h
1.60	677	522.0	387.8	232.9	140.9	84.4	60.6	47.65	39.90	26.98	21.15	11.70	9.86
1.65	612	493.7	371.9	224.6	139.1	82.9	59.6	46.85	39.23	26.53	21.07	11.60	9.77
1.70	584	463.2	364.0	221.6	136.3	80.5	58.2	45.79	38.35	25.93	20.92	11.48	9.67
1.75	538	438.8	349.0	218.0	133.1	78.1	56.7	44.60	37.35	25.26	20.89	11.25	9.48
1.80	493	414.3	329.6	211.8	129.7	77.4	55.9	43.94	36.79	24.88	20.81	11.25	9.48

Constant Power Discharge Data (Watts per cell at 20°C)

End Volt. Per Cell	5min	10min	15min	30min	1h	2h	3h	4h	5h	8h	10h	20h	24h
1.60	1114	873.9	692.2	437.2	270.2	162.2	117.9	91.54	76.04	52.94	43.83	22.50	18.96
1.65	1035	853.7	671.4	430.7	266.0	159.5	115.9	90.00	74.76	52.05	43.09	22.25	18.75
1.70	1011	819.3	654.1	421.2	258.1	157.5	114.5	88.88	73.83	51.40	42.55	21.97	18.51
1.75	976	799.0	637.9	411.6	251.5	153.5	111.5	86.59	71.93	50.08	41.46	21.83	18.39
1.80	899	762.5	615.4	397.1	244.9	148.2	107.7	83.65	69.49	48.38	40.05	21.63	18.22

Trickle (or float) Service Life

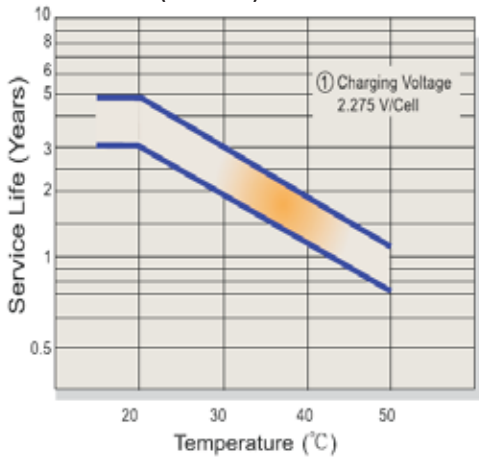

Capacity Retention Characteristic

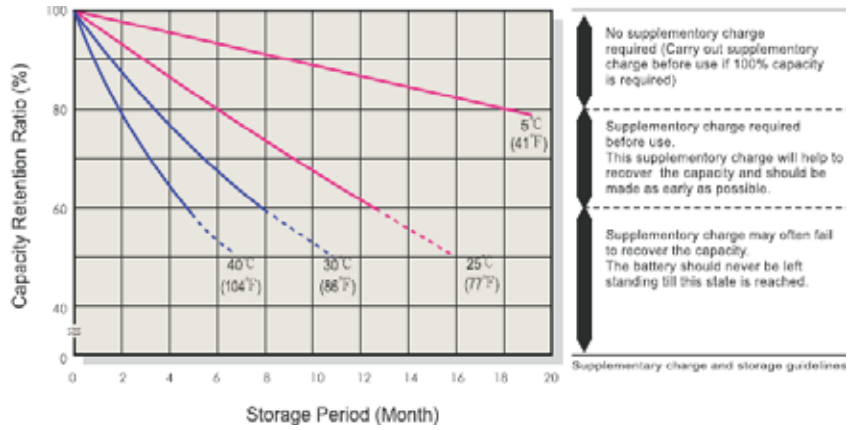

Battery Voltage and Charge Time for Standby Use

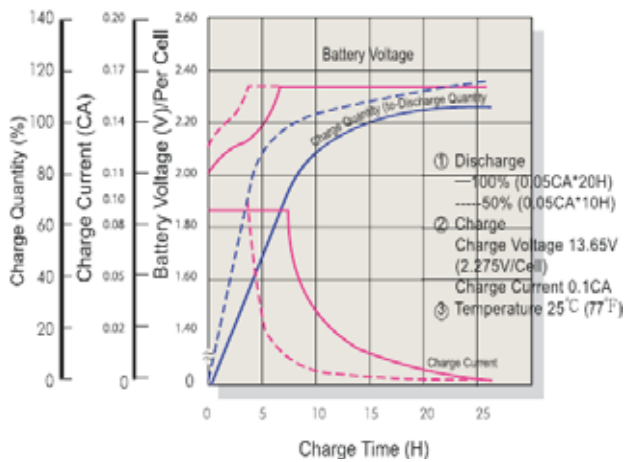

Terminal Voltage (V) and Discharge Time(20°C68°F)

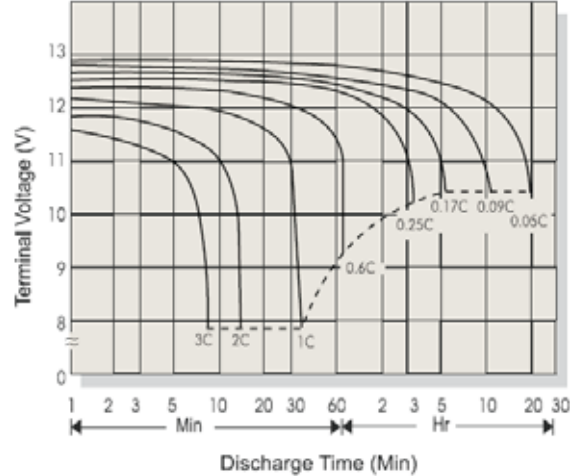

Charge Voltage depend on the temperature

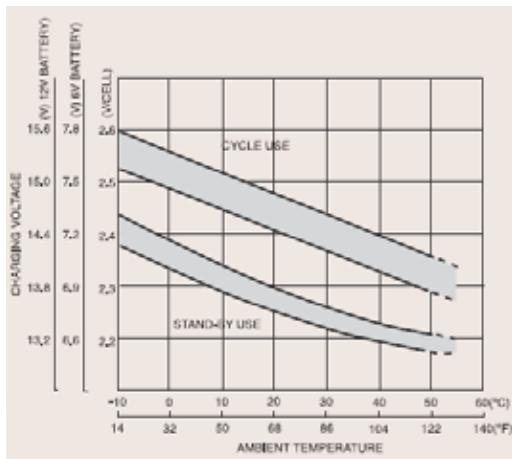

Capacity depend on the temperature

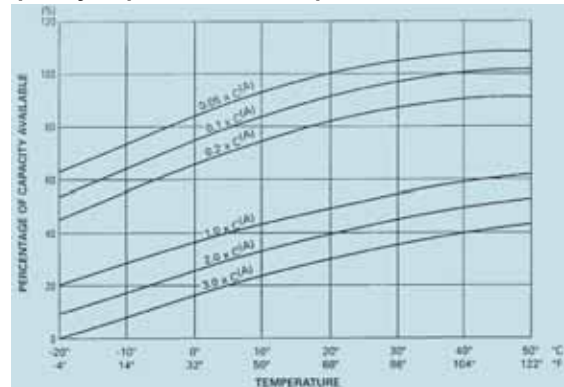

Charging Procedures

Application	Charge Voltage(V/Cell)			Max. Charge Current
	Temperature	Set Point	Allowable Ranges	
Cycle Use	20°C(68°F)	2.45	2.40~2.50	0.3C
Standby	20°C(68°F)	2.275	2.25~2.30	0.3C

Discharge Current VS. Discharge Voltage

Final Discharge Voltage V/Cell	1.75	1.70	1.60	1.40
Discharge Current(A)	0.2C>(A)	0.2C<(A)<0.5C	0.5C<(A)<1.0C	(A)>1.0C

Contact information

Shandong Sacred Sun Power Sources Co., Ltd.
Add: No.1, Shengyang Road, Qufu City, Shandong Province, China 273100
Tel: +86-537-4438 666 extn 6027 Fax: +86-537-4411 936
Website: <http://www.abtbatt.com> E-mail: sales@abtbatt.com

ABT VRLA Battery: Available Power Range From 7Ah to 3000Ah

Copyright SACREDSUN,
All rights reserved.
(Edition: May, 2011)